

**NOTES:**

- PUMP STATION MUST MEET ALL ZONING SET-BACK REQUIREMENTS
- PUMP STATION MUST MEET ALL LANDSCAPING REQUIREMENTS
- WATER SERVICE FOR YARD HYDRANT MUST HAVE RPZ PROTECTION
- PUMP STATION FENCE TO BE 50'X50' MINIMUM
- 5' BUFFER SHALL BE REQUIRED BETWEEN FENCE AND EASEMENT LINE.
- FOR ELECTRICAL PANEL REFER TO DETAILS S-9, S-10, S-11, S-12, AND S-13.
- REFER TO MINIMUM REQUIREMENTS FOR SEWER LIFT STATION-2007 edition
- GATE VALVES AND CHECK VALVES TO BE SIZED WITH FORCE MAIN
- CONCRETE FLOW METER VAULT SHOULD BE 4' WIDE X 4' DEEP AND 4' LONG AND IT MUST BE PROVIDED 4'X4' ALUMINUM BILCO HATCH
- CONCRETE VALVE VAULT SHOULD BE 6' WIDE X 3' DEEP AND 6' LONG AND IT MUST BE PROVIDED 4'X4' ALUMINUM BILCO HATCH
- NOTES 9 AND 10 DEPENDENT ON FORCE MAIN AND VALVE SIZE

**TYPICAL SUBMERSIBLE PUMP STATION LAYOUT DETAIL** S 1  
NO SCALE

\* FOR RAIN HOOD REFER TO DETAIL S-9  
\* SEE DETAIL S-7 FOR JUNCTION BOX

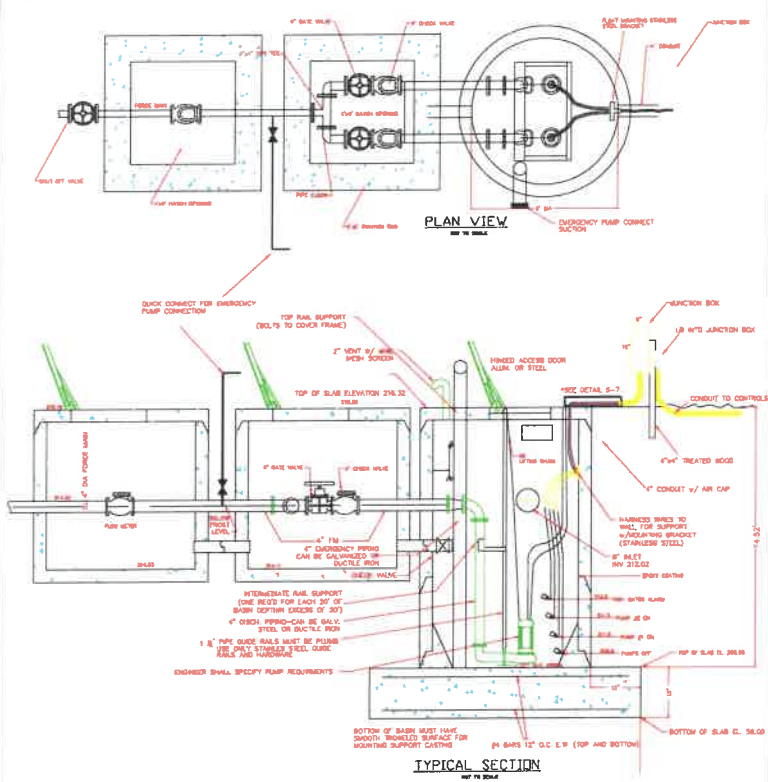

- GENERAL NOTES**
- ALL FIELD WIRING CONNECTIONS BETWEEN PUMPS, FLOAT SWITCHES AND CONTROL PANEL, BY LICENSED ELECTRICIAN.
  - ALL ENCLOSURES SHALL BE NEMA 4X STAINLESS STEEL.
  - PVC END CAP CAPPED TO ELBOW AND PERFORATED WITH 16 EA. 0.12" DIA. HOLES MAY BE USED IN LICH OF THE BIRD SCREEN.
  - RUN FLOAT SWITCH WIRES TO TERMINAL STRIP ON JUNCTION BOX AND FROM JUNCTION BOX TO CONTROL PANEL.
  - INSTALL AN INTER LOCKED RECEPTACLE WITH ENCLOSED DISCONNECT FOR TRANSFERRING LINE POWER TO PERMANENT GENERATOR IN THE EVENT OF A POWER FAILURE.
  - WIRE AND CONDUIT SIZE MAY VARY DEPENDING UPON PUMP REQUIREMENTS.
  - PUMP STATION BASE TO BE MANUFACTURED SPECIFICALLY FOR DIRECT MOUNTING TO OPEN TOP, 5' DIA. MANHOLE AND SHALL BE PROVIDED WITH ALL MOUNTING HARDWARE AND ANCHOR BOLT. ANCHOR BOLTS SHALL BE HARDENED ALLOY.
  - CIRCUITS SHALL BE IN DIRECT BURIED RIGID STEEL CONDUIT A MINIMUM OF 18" BELOW FINISHED GRADE.
  - ALL HARDWARE INSIDE WETWELL SHALL BE STAINLESS STEEL.
  - ENGINEER MUST PROVIDE ELEVATIONS FOR BASE, FLOATS, AND TOP

**TYPICAL BELOW GROUND PUMPS SEWER LIFT STATION DETAIL** S 2  
NO SCALE

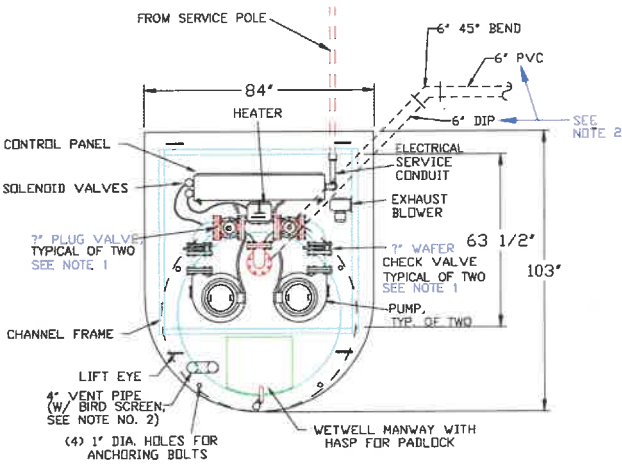

**TYPICAL PLAN VIEW OF SEWER LIFT STATION WITH ABOVE GROUND PUMPS DETAIL** S 3  
NO SCALE

- NOTES:**
- SIZES TO BE ADDED BY ENGINEER TO REPLACE ?
  - PIPE MATERIAL TO BE DIP UNLESS OTHERWISE SPECIFIED BY HCDPU.

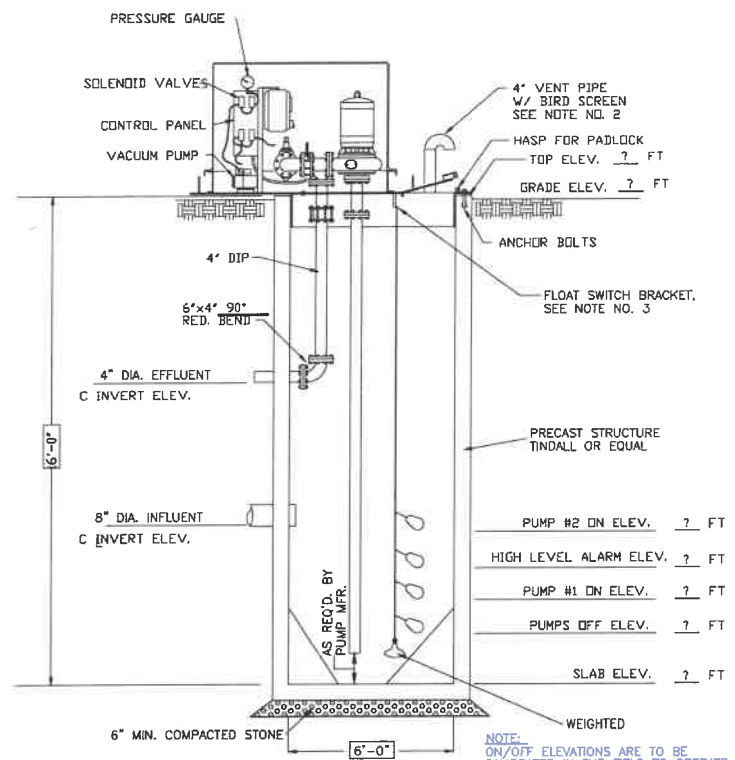

**TYPICAL SEWER LIFT STATION PROFILE FOR ABOVE GROUND PUMPS DETAIL** S 4  
NO SCALE

- NOTE:**
- ENGINEER MUST ADD ELEVATIONS PER PROJECT FOR BASE SLAB, FLOATS, & TOP TO REPLACE ?

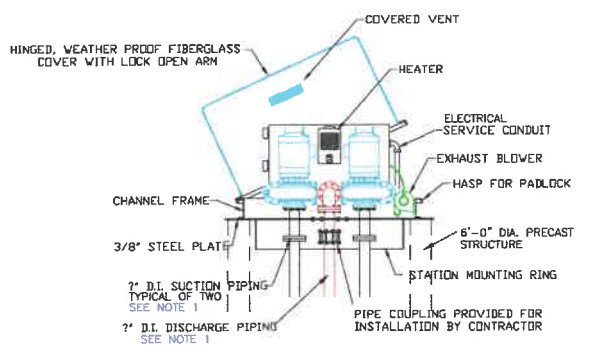

**TYPICAL PUMP ELEVATION FOR SEWER LIFT STATION WITH ABOVE GROUND PUMPS DETAIL** S 5  
NO SCALE

- NOTES:**
- ENGINEER TO SPECIFY PIPE SIZE PER PROJECT.
  - ENGINEER TO SPECIFY PUMP SIZE, FLOW, HEAD.

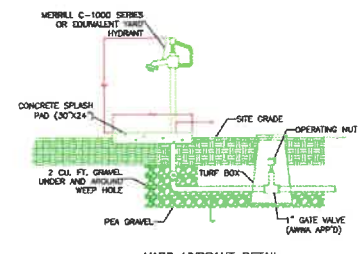

**TYPICAL YARD HYDRANT INSTALLATION DETAIL** S 6  
NO SCALE

Date: 2009		Date: 2009
Drawn By: H.C.D.P.U.		
Checked By: W.W.R.		Date: 2009
Book No.:		
Page No.:		Date: 2009
Job No.:		
Sheet No.:		Date: 2009
Scale: NOTED		
SANITARY SEWER DETAILS		Date: 2009
WASTE WATER SYSTEM		
HARNETT COUNTY SPECIFICATIONS		Date: 2009
HARNETT COUNTY - NORTH CAROLINA		
HARNETT COUNTY		Date: 2009
Public Utilities		
LILLINGTON, NORTH CAROLINA		Date: 2009
S:\harnett\MAIN SEWER & WATER DETAILS 2009\06-01-09-VIC Logos.dwg		
HARNETT COUNTY		Date: 2009
Public Utilities		
LILLINGTON, NORTH CAROLINA		Date: 2009
HARNETT COUNTY		
Public Utilities		Date: 2009
LILLINGTON, NORTH CAROLINA		
HARNETT COUNTY		Date: 2009
Public Utilities		
LILLINGTON, NORTH CAROLINA		Date: 2009
HARNETT COUNTY		
Public Utilities		Date: 2009
LILLINGTON, NORTH CAROLINA		
HARNETT COUNTY		Date: 2009
Public Utilities		
LILLINGTON, NORTH CAROLINA		Date: 2009
HARNETT COUNTY		
Public Utilities		Date: 2009
LILLINGTON, NORTH CAROLINA		
HARNETT COUNTY		Date: 2009
Public Utilities		
LILLINGTON, NORTH CAROLINA		Date: 2009
HARNETT COUNTY		
Public Utilities		Date: 2009
LILLINGTON, NORTH CAROLINA		
HARNETT COUNTY		Date: 2009
Public Utilities		
LILLINGTON, NORTH CAROLINA		Date: 2009
HARNETT COUNTY		
Public Utilities		Date: 2009
LILLINGTON, NORTH CAROLINA		
HARNETT COUNTY		Date: 2009
Public Utilities		
LILLINGTON, NORTH CAROLINA		Date: 2009
HARNETT COUNTY		
Public Utilities		Date: 2009
LILLINGTON, NORTH CAROLINA		
HARNETT COUNTY		Date: 2009
Public Utilities		
LILLINGTON, NORTH CAROLINA		Date: 2009
HARNETT COUNTY		
Public Utilities		Date: 2009
LILLINGTON, NORTH CAROLINA		
HARNETT COUNTY		Date: 2009
Public Utilities		
LILLINGTON, NORTH CAROLINA		Date: 2009
HARNETT COUNTY		
Public Utilities		Date: 2009
LILLINGTON, NORTH CAROLINA		
HARNETT COUNTY		Date: 2009
Public Utilities		
LILLINGTON, NORTH CAROLINA		Date: 2009
HARNETT COUNTY		
Public Utilities		Date: 2009
LILLINGTON, NORTH CAROLINA		
HARNETT COUNTY		Date: 2009
Public Utilities		
LILLINGTON, NORTH CAROLINA		Date: 2009
HARNETT COUNTY		
Public Utilities		Date: 2009
LILLINGTON, NORTH CAROLINA		
HARNETT COUNTY		Date: 2009
Public Utilities		
LILLINGTON, NORTH CAROLINA		Date: 2009
HARNETT COUNTY		
Public Utilities		Date: 2009
LILLINGTON, NORTH CAROLINA		
HARNETT COUNTY		Date: 2009
Public Utilities		
LILLINGTON, NORTH CAROLINA		Date: 2009
HARNETT COUNTY		
Public Utilities		Date: 2009
LILLINGTON, NORTH CAROLINA		
HARNETT COUNTY		Date: 2009
Public Utilities		
LILLINGTON, NORTH CAROLINA		Date: 2009
HARNETT COUNTY		
Public Utilities		Date: 2009
LILLINGTON, NORTH CAROLINA		
HARNETT COUNTY		Date: 2009
Public Utilities		
LILLINGTON, NORTH CAROLINA		Date: 2009
HARNETT COUNTY		
Public Utilities		Date: 2009
LILLINGTON, NORTH CAROLINA		
HARNETT COUNTY		Date: 2009
Public Utilities		
LILLINGTON, NORTH CAROLINA		Date: 2009
HARNETT COUNTY		
Public Utilities		Date: 2009
LILLINGTON, NORTH CAROLINA		
HARNETT COUNTY		Date: 2009
Public Utilities		
LILLINGTON, NORTH CAROLINA		Date: 2009
HARNETT COUNTY		
Public Utilities		Date: 2009
LILLINGTON, NORTH CAROLINA		
HARNETT COUNTY		Date: 2009
Public Utilities		
LILLINGTON, NORTH CAROLINA		Date: 2009
HARNETT COUNTY		
Public Utilities		Date: 2009
LILLINGTON, NORTH CAROLINA		
HARNETT COUNTY		Date: 2009
Public Utilities		
LILLINGTON, NORTH CAROLINA		Date: 2009
HARNETT COUNTY		
Public Utilities		Date: 2009
LILLINGTON, NORTH CAROLINA		
HARNETT COUNTY		Date: 2009
Public Utilities		
LILLINGTON, NORTH CAROLINA		Date: 2009
HARNETT COUNTY		
Public Utilities		Date: 2009
LILLINGTON, NORTH CAROLINA		
HARNETT COUNTY		Date: 2009
Public Utilities		
LILLINGTON, NORTH CAROLINA		Date: 2009
HARNETT COUNTY		
Public Utilities		Date: 2009
LILLINGTON, NORTH CAROLINA		
HARNETT COUNTY		Date: 2009
Public Utilities		
LILLINGTON, NORTH CAROLINA		Date: 2009
HARNETT COUNTY		
Public Utilities		Date: 2009
LILLINGTON, NORTH CAROLINA		
HARNETT COUNTY		Date: 2009
Public Utilities		
LILLINGTON, NORTH CAROLINA		Date: 2009
HARNETT COUNTY		
Public Utilities		Date: 2009
LILLINGTON, NORTH CAROLINA		
HARNETT COUNTY		Date: 2009
Public Utilities		
LILLINGTON, NORTH CAROLINA		Date: 2009
HARNETT COUNTY		
Public Utilities		Date: 2009
LILLINGTON, NORTH CAROLINA		
HARNETT COUNTY		Date: 2009
Public Utilities		
LILLINGTON, NORTH CAROLINA		Date: 2009
HARNETT COUNTY		
Public Utilities		Date: 2009
LILLINGTON, NORTH CAROLINA		
HARNETT COUNTY		Date: 2009
Public Utilities		
LILLINGTON, NORTH CAROLINA		Date: 2009
HARNETT COUNTY		
Public Utilities		Date: 2009
LILLINGTON, NORTH CAROLINA		
HARNETT COUNTY		Date: 2009
Public Utilities		
LILLINGTON, NORTH CAROLINA		Date: 2009
HARNETT COUNTY		
Public Utilities		Date: 2009
LILLINGTON, NORTH CAROLINA		
HARNETT COUNTY		Date: 2009
Public Utilities		
LILLINGTON, NORTH CAROLINA		Date: 2009
HARNETT COUNTY		
Public Utilities		Date: 2009
LILLINGTON, NORTH CAROLINA		
HARNETT COUNTY		Date: 2009
Public Utilities		
LILLINGTON, NORTH CAROLINA		Date: 2009
HARNETT COUNTY		
Public Utilities		Date: 2009
LILLINGTON, NORTH CAROLINA		
HARNETT COUNTY		Date: 2009
Public Utilities		
LILLINGTON, NORTH CAROLINA		Date: 2009
HARNETT COUNTY		
Public Utilities		Date: 2009
LILLINGTON, NORTH CAROLINA		
HARNETT COUNTY		Date: 2009
Public Utilities		
LILLINGTON, NORTH CAROLINA		Date: 2009
HARNETT COUNTY		
Public Utilities		Date: 2009
LILLINGTON, NORTH CAROLINA		
HARNETT COUNTY		Date: 2009
Public Utilities		
LILLINGTON, NORTH CAROLINA		Date: 2009
HARNETT COUNTY		
Public Utilities		Date: 2009
LILLINGTON, NORTH CAROLINA		
HARNETT COUNTY		Date: 2009
Public Utilities		
LILLINGTON, NORTH CAROLINA		Date: 2009
HARNETT COUNTY		
Public Utilities		Date: 2009
LILLINGTON, NORTH CAROLINA		
HARNETT COUNTY		Date: 2009
Public Utilities		
LILLINGTON, NORTH CAROLINA		Date: 2009
HARNETT COUNTY		
Public Utilities		Date: 2009
LILLINGTON, NORTH CAROLINA		
HARNETT COUNTY		Date: 2009
Public Utilities		
LILLINGTON, NORTH CAROLINA		Date: 2009
HARNETT COUNTY		
Public Utilities		Date: 2009
LILLINGTON, NORTH CAROLINA		
HARNETT COUNTY		Date: 2009
Public Utilities		
LILLINGTON, NORTH CAROLINA		Date: 2009
HARNETT COUNTY		
Public Utilities		Date: 2009
LILLINGTON, NORTH CAROLINA		
HARNETT COUNTY		Date: 2009
Public Utilities		
LILLINGTON, NORTH CAROLINA		Date: 2009
HARNETT COUNTY		
Public Utilities		Date: 2009
LILLINGTON, NORTH CAROLINA		
HARNETT COUNTY		Date: 2009
Public Utilities		
LILLINGTON, NORTH CAROLINA		Date: 2009
HARNETT COUNTY		
Public Utilities		Date: 2009
LILLINGTON, NORTH CAROLINA		
HARNETT COUNTY		Date: 2009
Public Utilities		
LILLINGTON, NORTH CAROLINA		Date: 2009
HARNETT COUNTY		
Public Utilities		Date: 2009
LILLINGTON, NORTH CAROLINA		
HARNETT COUNTY		Date: 2009
Public Utilities		
LILLINGTON, NORTH CAROLINA		Date: 2009
HARNETT COUNTY		
Public Utilities		Date: 2009
LILLINGTON, NORTH CAROLINA		
HARNETT COUNTY		Date: 2009
Public Utilities		
LILLINGTON, NORTH CAROLINA		Date: 2009
HARNETT COUNTY		
Public Utilities		Date: 2009
LILLINGTON, NORTH CAROLINA		
HARNETT COUNTY		Date: 2009
Public Utilities		
LILLINGTON, NORTH CAROLINA		Date: 2009
HARNETT COUNTY		
Public Utilities		Date: 2009
LILLINGTON, NORTH CAROLINA		
HARNETT COUNTY		Date: 2009
Public Utilities		
LILLINGTON, NORTH CAROLINA		Date: 2009
HARNETT COUNTY		
Public Utilities		Date: 2009
LILLINGTON, NORTH CAROLINA		
HARNETT COUNTY		Date: 2009
Public Utilities		
LILLINGTON, NORTH CAROLINA		Date: 2009
HARNETT COUNTY		
Public Utilities		Date: 2009
LILLINGTON, NORTH CAROLINA		
HARNETT COUNTY		Date: 2009
Public Utilities		
LILLINGTON, NORTH CAROLINA		Date: 2009
HARNETT COUNTY		
Public Utilities		Date: 2009
LILLINGTON, NORTH CAROLINA		
HARNETT COUNTY		Date: 2009
Public Utilities		
LILLINGTON, NORTH CAROLINA		Date: 2009
HARNETT COUNTY		
Public Utilities		Date: 2009
LILLINGTON, NORTH CAROLINA		
HARNETT COUNTY		Date: 2009
Public Utilities		
LILLINGTON, NORTH CAROLINA		Date: 2009
HARNETT COUNTY		
Public Utilities		Date: 2009
LILLINGTON, NORTH CAROLINA		
HARNETT COUNTY		Date: 2009
Public Utilities		
LILLINGTON, NORTH CAROLINA		Date: 2009
HARNETT COUNTY		
Public Utilities		Date: 2009
LILLINGTON, NORTH CAROLINA		
HARNETT COUNTY		Date: 2009
Public Utilities		
LILLINGTON, NORTH CAROLINA		Date: 2009
HARNETT COUNTY		
Public Utilities		Date: 2009
LILLINGTON, NORTH CAROLINA		
HARNETT COUNTY		Date: 2009
Public Utilities		
LILLINGTON, NORTH CAROLINA		Date: 2009
HARNETT COUNTY		
Public Utilities		Date: 2009
LILLINGTON, NORTH CAROLINA		
HARNETT COUNTY		Date: 2009
Public Utilities		
LILLINGTON, NORTH CAROLINA		Date: 2009
HARNETT COUNTY		
Public Utilities		Date: 2009
LILLINGTON, NORTH CAROLINA		
HARNETT COUNTY		Date: 2009
Public Utilities		
LILLINGTON, NORTH CAROLINA		Date: 2009
HARNETT COUNTY		
Public Utilities		Date: 2009
LILLINGTON, NORTH CAROLINA		
HARNETT COUNTY		Date: 2009
Public Utilities		
LILLINGTON, NORTH CAROLINA		Date: 2009
HARNETT COUNTY		
Public Utilities		Date: 2009
LILLINGTON, NORTH CAROLINA		
HARNETT COUNTY		Date: 2009
Public Utilities		
LILLINGTON, NORTH CAROLINA		Date: 2009
HARNETT COUNTY		
Public Utilities		Date: 2009
LILLINGTON, NORTH CAROLINA		
HARNETT COUNTY		Date: 2009
Public Utilities		
LILLINGTON, NORTH CAROLINA		Date: 2009
HARNETT COUNTY		
Public Utilities		Date: 2009
LILLINGTON, NORTH CAROLINA		
HARNETT COUNTY		Date: 2009
Public Utilities		
LILLINGTON, NORTH CAROLINA		Date: 2009
HARNETT COUNTY		
Public Utilities		Date: 2009
LILLINGTON, NORTH CAROLINA		
HARNETT COUNTY		Date: 2009
Public Utilities		
LILLINGTON, NORTH CAROLINA		Date: 2009
HARNETT COUNTY		
Public Utilities		Date: 2009
LILLINGTON, NORTH CAROLINA		
HARNETT COUNTY		Date: 2009
Public Utilities		
LILLINGTON, NORTH CAROLINA		Date



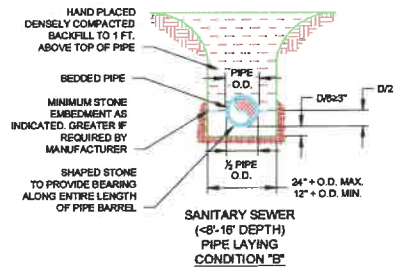
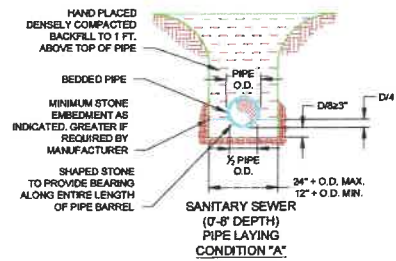

TYPICAL PIPE LAYING CONDITION DETAIL S 16  
NO SCALE

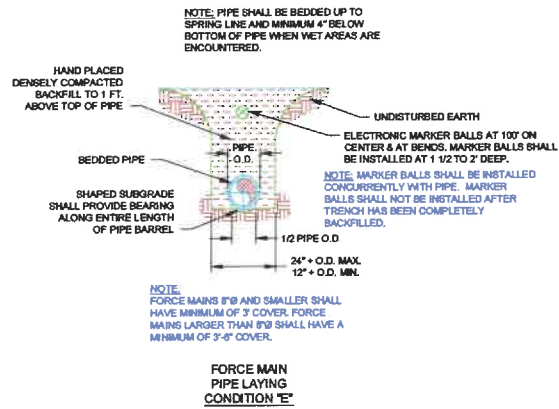

TYPICAL PIPE LAYING CONDITION DETAILS S 18  
NO SCALE

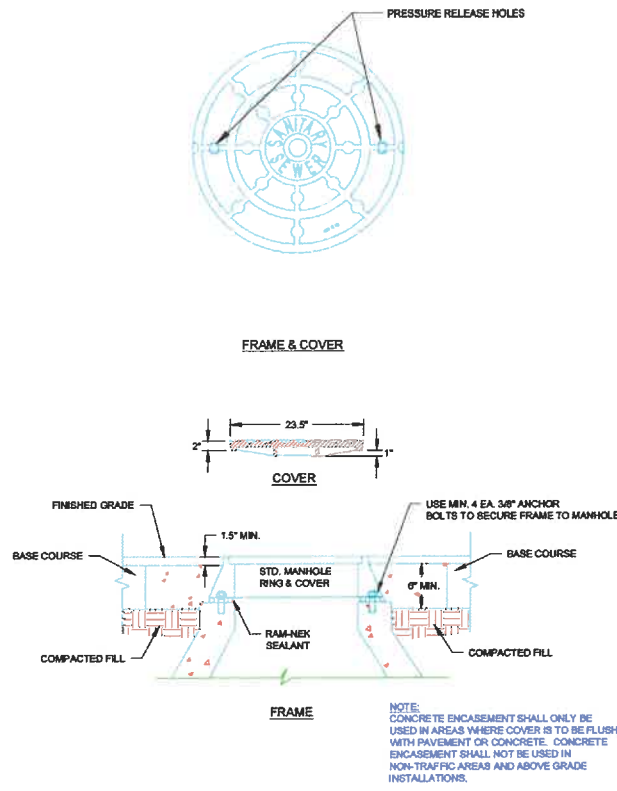

TYPICAL PRESSURE RELEASE MANHOLE FRAME & COVER DETAIL S 20  
NO SCALE

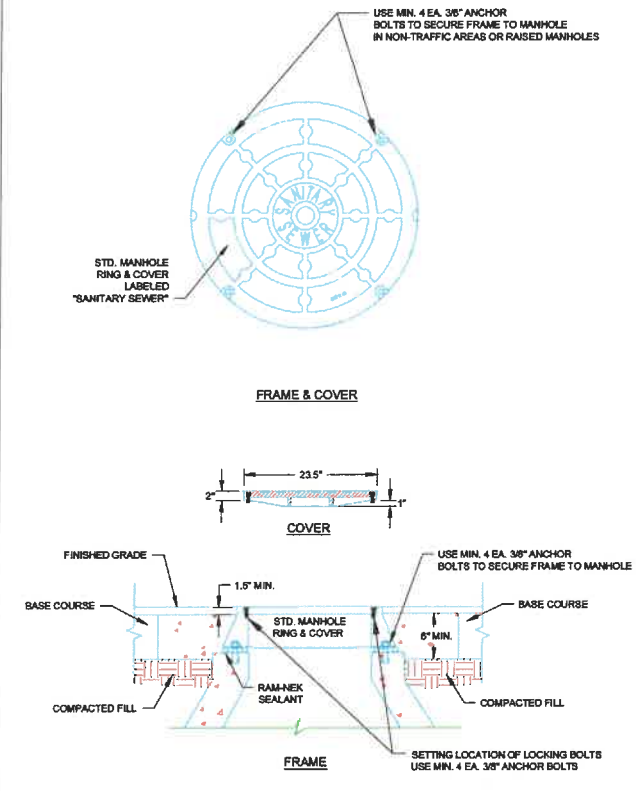

TYPICAL LOCKABLE MANHOLE FRAME & COVER DETAIL S 22  
NO SCALE

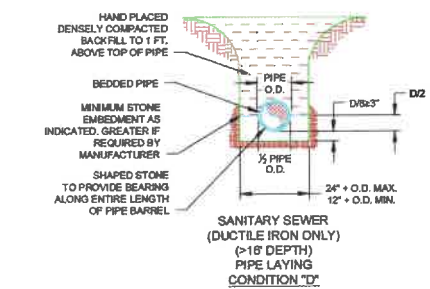
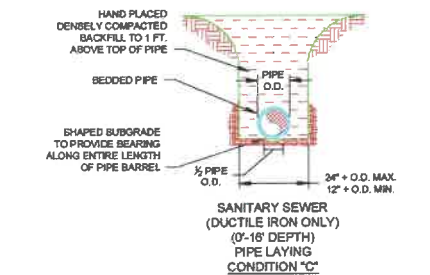

TYPICAL PIPE LAYING CONDITION DETAIL S 17  
NO SCALE

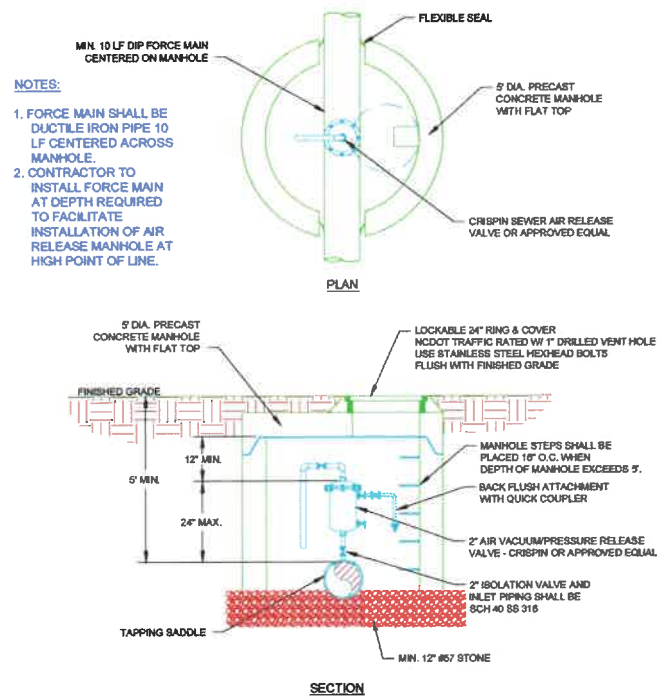

TYPICAL AIR VACUUM/RELEASE MANHOLE FOR FORCE MAIN DETAIL S 19  
NO SCALE

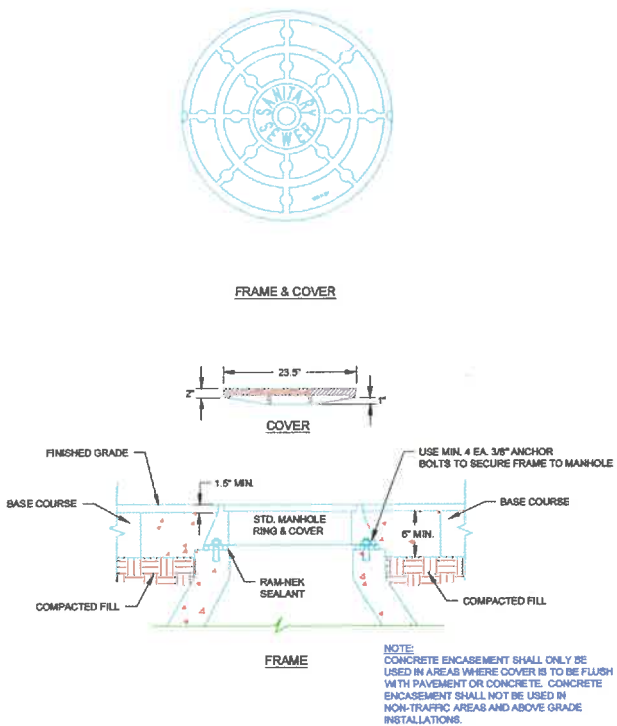



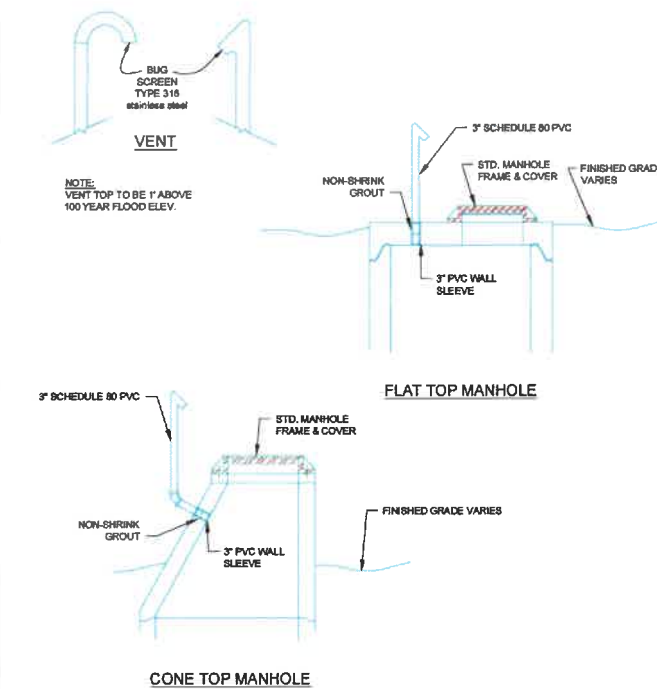

TYPICAL STANDARD MANHOLE FRAME & COVER DETAIL S 21  
NO SCALE



TYPICAL VENTED MANHOLE DETAIL S 23  
NO SCALE

<p><b>HARNETT County</b> Public Utilities WILLINGTON, NORTH CAROLINA</p>	
<p>S:\Mapping\MAIN SEWER &amp; WATER DETAILS 809\36\HARNETT Logos.dwg</p>	
<p>SANITARY SEWER DETAILS WASTE WATER SYSTEM</p>	
<p><b>HARNETT COUNTY SPECIFICATIONS</b> HARNETT COUNTY - NORTH CAROLINA</p>	
Scale:	NOTED
Date:	2009
Drawn By:	H.C.D.P.U.
Checked By:	W.W.R.
Book No.:	
Page No.:	
Job No.:	
Sheet No.:	WW-3

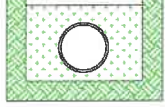

LAYING CONDITIONS	DESCRIPTION	PROJECT USE
 TYPE 1	FLAT BOTTOM UNDISTURBED EARTH TRENCH, LOOSE BACKFILL	NOT USED.
 TYPE 2	FLAT BOTTOMED UNDISTURBED EARTH TRENCH, BACKFILL LIGHTLY CONSOLIDATED TO CENTERLINE OF PIPE.	NOT USED.
 TYPE 3	PIPE BEDDED IN 4" MINIMUM JOB EXCAVATED MATERIAL, BACKFILL LIGHTLY CONSOLIDATED TO TOP OF PIPE.	ALL DUCTILE IRON GRAVITY SEWER LINE.
 TYPE 4	PIPE BEDDED IN SAND, GRANULAR MATERIAL OR GRADED GRAVEL TO THE DEPTH OF 1/8 PIPE DIAMETER, 4" MIN. JOB EXCAVATED MATERIAL COMPACTED TO 4" ABOVE TOP OF PIPE. (APPROX. 95% STANDARD PROCTOR, AASHTO T-99)	ALL PVC WATER LINE AND PVC FORCE MAIN.
 TYPE 5	PIPE BEDDED TO ITS CENTERLINE IN COMPACTED GRANULAR MATERIAL 4" MIN. UNDER PIPE, COMPACTED GRANULAR OR SAND MATERIAL TO 4" ABOVE TOP OF PIPE. (APPROX. 95% STANDARD PROCTOR, AASHTO T-99)	ALL PVC GRAVITY SEWER LINE.

TYPICAL LAYING CONDITIONS DETAIL S 33  
NO SCALE

MINIMUM SPECIFIED TIME REQUIRED FOR 0 PSIG PRESSURE DROP AT 5 PSI FOR SIZE AND LENGTH OF PIPE INDICATED FOR Q = 0.0015

1 Pipe Diameter (in.)	2 Minimum Time (min:sec)	3 Length for Minimum Time (ft)	4 Time for Longer Length (sec)	Specification Time for Length (L) Shown (min:sec)							
				100 ft	150 ft	200 ft	250 ft	300 ft	350 ft	400 ft	450 ft
4	1:53	597	.190 L	1:53	1:53	1:53	1:53	1:53	1:53	1:53	1:53
6	2:50	398	.427 L	2:50	2:50	2:50	2:50	2:50	2:50	2:51	3:12
8	3:47	298	.760 L	4:00	4:00	4:00	4:00	4:00	4:26	5:04	5:42
10	4:43	239	1.187 L	4:43	4:43	4:43	4:57	5:56	6:55	7:54	8:54
12	5:40	199	1.709 L	5:40	5:40	5:42	7:08	8:33	9:58	11:24	12:50
15	7:05	159	2.671 L	7:05	7:05	8:54	11:08	13:21	15:35	17:48	20:02
18	8:30	133	3.846 L	8:30	9:37	12:49	16:01	19:14	22:26	25:38	28:51
21	9:55	114	5.235 L	9:55	13:05	17:27	21:49	26:11	30:32	34:54	39:16
24	11:20	99	6.837 L	11:24	17:57	22:48	28:30	34:11	39:53	45:35	51:17
27	12:45	88	8.653 L	14:25	21:38	28:51	36:04	43:16	50:30	57:42	64:54
30	14:10	80	10.683 L	17:48	26:43	35:37	44:31	53:25	62:19	71:13	80:07
33	15:35	72	12.926 L	21:33	32:19	43:56	53:52	64:38	75:24	86:10	96:57
36	17:00	66	15.384 L	25:39	38:28	51:17	64:06	76:55	89:44	102:34	115:23
42	19:54	57	20.942 L	34:54	52:21	69:49	87:15	104:42	122:10	139:37	157:04
48	22:47	50	27.352 L	45:35	68:23	91:11	113:58	136:46	159:33	182:21	205:09
54	25:31	44	34.618 L	57:42	86:33	115:24	144:15	173:05	201:56	230:47	259:38
60	28:20	40	42.738 L	71:14	106:51	142:28	178:05	213:41	249:18	284:55	320:32

Note: If there has been no leakage (zero psig drop) after one hour of testing, the test section shall be accepted and the test complete

SEWER TESTING TIME TABLE S 34

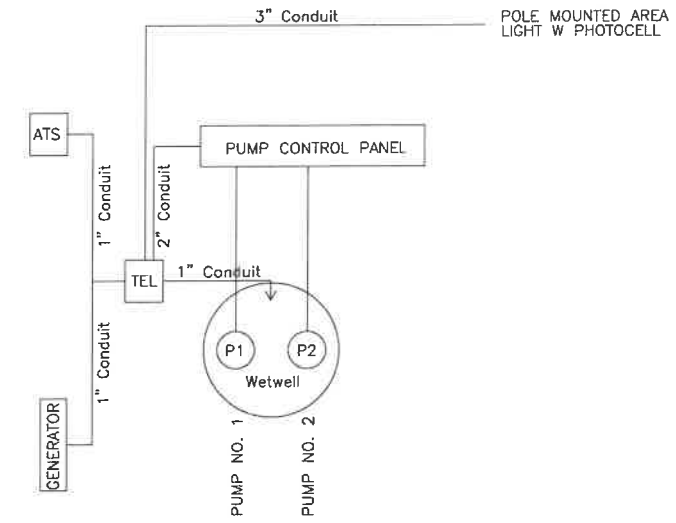

TYPICAL SCADA ONE-LINE DIAGRAM DETAIL S 11a  
NO SCALE

NOTE:  
1. Pull string in all SCADA race ways

<p>HARNETT COUNTY Public Utilities WILMINGTON, NORTH CAROLINA</p>	<p>SANITARY SEWER DETAILS WASTE WATER SYSTEM HARNETT COUNTY - NORTH CAROLINA</p>
<p>Scale: NOTED Date: 2009 Drawn By: H.C.D.P.U. Checked By: W.W.R. Book No.: Page No.: Job No.: Sheet No.: WW-5</p>	<p>Mark Revisions Date App'd.</p>